



Modulating refrigerant valves with magnetic actuator, PN 32

M3FK..LX..

hermetically sealed, for condenser control

- **Mixing or straight-through valves with magnetic actuator for modulating capacity control of condensers.**
- **Short positioning time (approx. 1 s)**
- **High resolution**
- **High rangeability**
- **Hermetically sealed**
- **Versatile electrical interface**
- **Friction-free**
- **Port 1 -> 3 closed when de-energized**
- **Robust and maintenance-free**

Use

The M3FK..LX.. mixing or straight-through valves with magnetic actuator can be used for modulating capacity control of condensers. They may be used for liquid or gas control.

Suitable for safety refrigerants such as R22, R134a, R404A, R407C, R507, etc.

Type summary

Type reference	DN	k _{vs} [m ³ /h]	Δp _{max}		S _{NA} [VA]	P _{med} [W]
			Liquid [MPa]	Gas [bar]		
M3FK15LX06	15	0.6	0.2	0.8	13	3
M3FK15LX15	15	1.5			13	3
M3FK15LX	15	3.0			13	3
M3FK20LX	20	5.0			16	4
M3FK25LX	25	8.0			16	4
M3FK32LX	32	12.0			20	5
M3FK40LX	40	20.0			40	10
M3FK50LX	50	30.0			40	10

Δp_{max} = Maximum permissible differential pressure across the valve's control path 1 → 3 valid for the entire actuating range
S_{NA} = Rated apparent power for transformer selection
P_{med} = Typical power consumption
k_{vs} = Nominal flow rate of cold water through the fully open valve (H₁₀₀) by a differential pressure of 100 kPa (1 bar), to VDI 2173

Accessories / ZM.. terminal housing

Type reference	Operating voltage	Positioning signal	Working range	Data sheet
ZM101/A	AC 24 V	DC 0...10 V	DC 4...8 V	N4591
ZM121/A	AC 24 V	DC 4...20 mA	DC 8...16 mA	
ZM111		DC 0...20 V Phs	DC 10...15 V Phs	

For the ZM101/A and ZM121/A types also the DC 0...20 V Phs positioning signal is possible without operating voltage.

Order

The M3FK..LX.. valve and the ZM.. or ZM../A terminal housing must be ordered separately.

When placing an order, please specify the quantity, product description and type code.

Type reference	Stock number	Description
M3FK15LX	M3FK15LX	Refrigerant valve
ZM101/A	ZM101/A	Terminal housing

Delivery

Valves and terminal housings are packed separately.

Rev. no.

Overview table, see page 9.

Technical and mechanical design

The armature or magnetic core is designed as a floating component within the pressure system, so that no external shaft gland is required. The leakage losses common with moving parts are thus avoided. The valve cross-section allows for easy flow whether the valve is fully or only partially open. This reduces pressure losses and ensures quiet operation.

The valves are fitted with extended female solder unions, making pipe connection easy.

The control signal is converted in the ZM../A terminal housing into a phase cut signal, which generates a magnetic field in the coil. This causes the only moving part, the armature, to change its position in accordance with the interacting forces (magnetic field, counter-spring, hydraulics etc.). The armature responds rapidly to any change in signal, transferring the corresponding movement directly to the control disc, enabling fast changes in load to be corrected quickly and accurately.

The force of the counter-spring closes the valve automatically (control path ports 1 → 3) if the power is switched off or fails.

Sizing

Correct valve sizing (to ensure a sufficiently large pressure drop Δp_{V100} across the fully open valve) is the key to the correct operation of a refrigeration unit. All the components must be coordinated, and this can be ensured only by the refrigeration specialist. The application examples on pages 5 and show the recommended pressure drop in each case.

Refrigeration capacity Q_0

Pressure differential $\Delta p_{V100} = 0.5$ bar across the fully-open valve. Nominal capacity Q_0 in kW at an evaporation temperature t_0 of 5 °C and a liquid temperature t_{fl} of 30 °C.

Selection table for approximate guide to valve size

Valve type	Hot gas									Liquid					
	R407C (R22)			R134a (R12)			R404A / R507			R407C (R22)		R134a (R12)		R404A R507	
	Condensation temperature t_c [°C]									Liquid temperature t_{fl} [°C]					
	30	40	50	30	40	50	30	40	50	30	40	30	40	30	40
M3FK15LX06	4.5	4.0	3.6	3.7	3.3	2.9	3.6	3.2	2.9	21	19	20	18	15	12
M3FK15LX15	11	10	8.9	9.2	8.2	7.2	8.9	8.0	7.2	54	49	51	45	37	31
M3FK15LX	22	20	18	18	16	14	18	16	14	107	97	102	91	74	62
M3FK20LX	37	33	30	31	27	24	30	27	24	179	162	170	151	124	103
M3FK25LX	59	53	48	49	44	38	47	43	38	286	259	272	242	199	165
M3FK32LX	89	80	72	74	66	57	71	64	58	429	389	408	364	298	248
M3FK40LX	149	134	119	123	109	96	119	107	96	715	648	681	606	497	413
M3FK50LX	223	201	179	184	164	143	178	160	144	1073	971	1021	909	745	619

Δp_{V100} = Differential pressure across the fully open valve (control path 1 → 3) by a volume flow \dot{V}_{100}

Selection chart

50320A

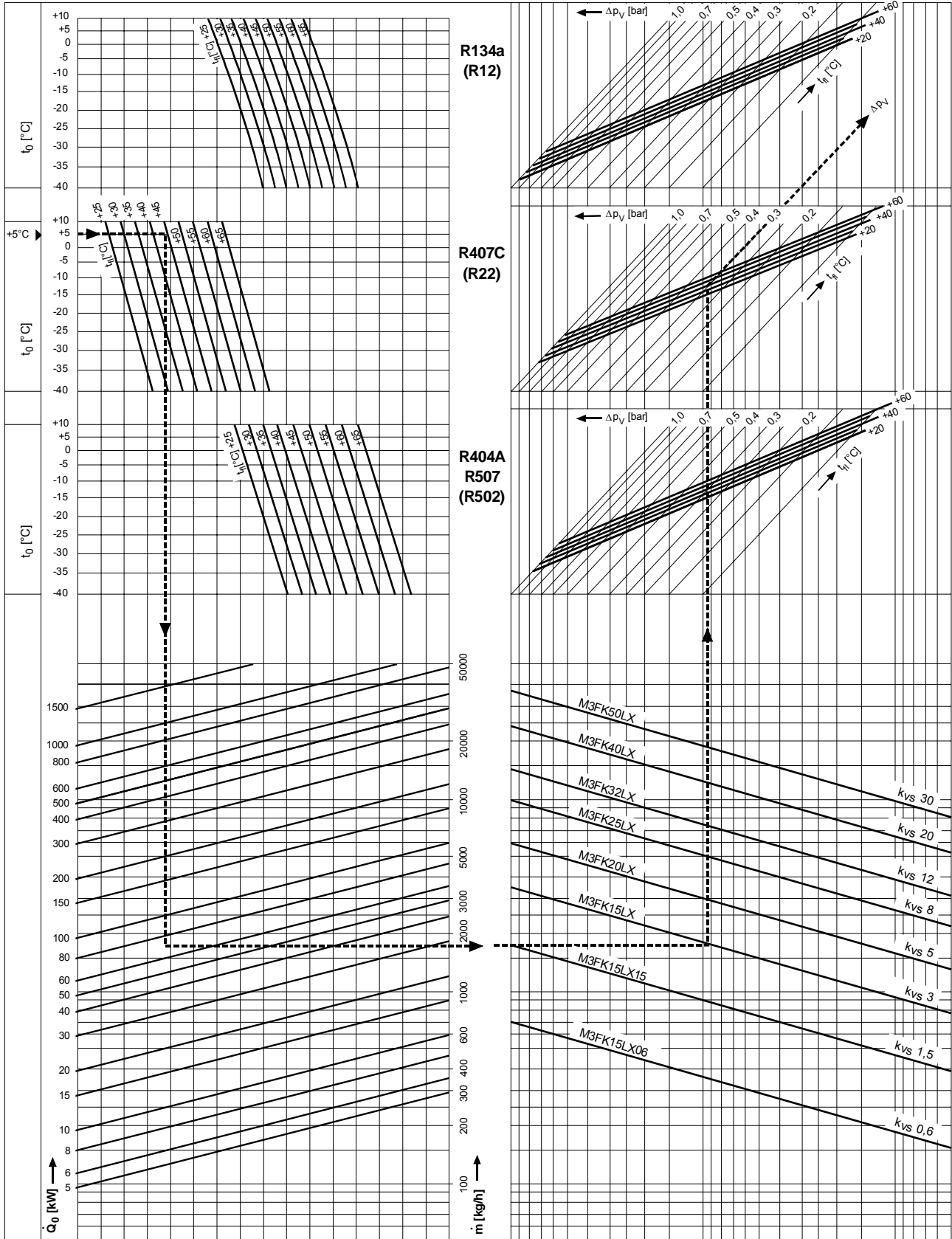

- t_0 = Evaporation temperature [°C]
- t_c = Condensation temperature [°C]
- t_n = t_c - degree of sub-cooling [°C]
- Q_0 = Refrigeration capacity [kW]
- m = Mass flow of refrigerant [kg/h]
- Δp_{v100} = Admissible differential pressure [bar], installation-specific
- k_{vs} = Nominal flow rate [m³/h] of cold water through the fully open valve (H_{100}) by a differential pressure of 100 kPa (1 bar)

The diagrams shown here are principles only, without installation-specific details.

3-way hot-gas bypass control

The heat recovery condenser is connected in parallel with the main condenser and is controlled on the liquid side by a mixing valve.

Recommended pressure drop Δp_{V100} across the fully-open valve (control path 1 → 3) $0.5 < \Delta p_{V100} < 1$ bar (see selection chart)

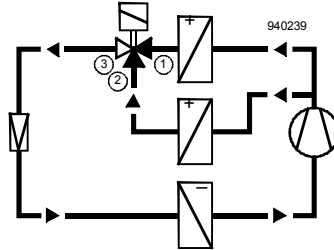

Example:

Refrigeration capacity Q_0	73 kW
Refrigerant	R22
Condensation temperature t_c	50 °C
Evaporation temperature t_0	+ 5 °C
Liquid temperature t_{fl}	45 °C
Selected valve	M3FK15LX
Actual differential pressure Δp_{V100} across valve	0,32 bar

Hot-gas control

The heat-recovery condenser is connected in series upstream of the main condenser (the most common application). The selected control valve is sized for hot gas (see data sheet 4721).

Recommended pressure drop Δp_{V100} across the fully-open valve (control path 1 → 3) $0.5 < \Delta p_{V100} < 1$ bar (see selection chart)

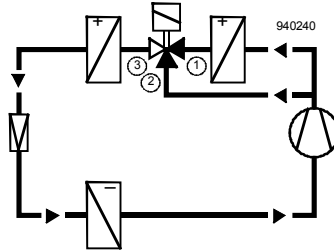

Example:

Refrigeration capacity Q_0	73 kW
Refrigerant	R22
Condensation temperature t_c	50 °C
Evaporation temperature t_0	5 °C
Liquid temperature t_{fl}	45 °C
Selected valve	M3FK32LX
Actual differential pressure Δp_{V100} across valve	0,45 bar

Mounting notes

Mounting instructions are enclosed with the valve:

- Nr. 35551 (valve)
- Nr. 35541 (ZM.. terminal housing)

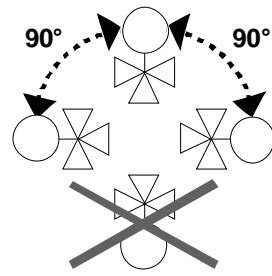

472Z01

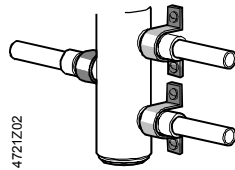

472Z02

- The refrigerant valves can be mounted in any orientation, but upright mounting is preferable.
- The pipes should be fitted such that the alignment does not distort the valve connections. The valve body should be fixed such that it cannot vibrate. Vibration can lead to burst connection pipes.
- Before soldering the pipes, ensure that the direction of flow through the valve is correct.
- The pipes must be soldered with care. To avoid dirt and the formation of scale (oxide), inert gas is recommended for soldering.
- The flame should be large enough to ensure that the junction heats up quickly and the valve does not get too hot.
- The flame should be directed away from the valve.
- During soldering, cool the valve with a wet cloth, for example, to ensure that it does not become too hot
- Port 2 must be sealed off when the valve is used in a straight-through application (1 → 3).
- The valve body and the connected pipework should be lagged.
- The actuator must not be lagged.

Caution Always switch off the power supply before connecting or disconnecting the ZM.. terminal housing.

Maintenance

The M3FK..LX.. modulating control valves are maintenance-free.

Repair

The valve cannot be repaired. It has to be replaced as a complete unit.

Disposal



The valve is considered an electronics device for disposal in terms of European Directive 2012/19/EU and may not be disposed of as domestic garbage.

- Disassemble the valve into individual parts prior to disposing of it and sort the individual parts by the various types of materials.
- Comply with all local and currently applicable laws and regulations.

Warranty

Application-specific technical data must be observed.

If specified limits are not observed, Siemens Switzerland Ltd / HVAC Products will nor assume any responsibility.

Technical data

Functional actuator data

Power supply	Extra low-voltage only (SELV, PELV)		
	Operating voltage ¹⁾	AC 24 V + 15 % / -10 %	
	Frequency	50...60 Hz	
	Typical power consumption P_{med}	refer to «Type summary» table	
	Rated apparent power S_{NA}	refer to «Type summary» table	
	Required fuse I_F	1.6...4 A, slow	
Input	Positioning signal	ZM101/A DC 0...10 V or DC 0...20 V Phs (phase cut) ZM121/A DC 4...20 mA or DC 0...20 V Phs ZM111 DC 0...20 V Phs	
	Input resistance DC 0...10 V	> 100 k Ω	
	Input resistance DC 4...20 mA	< 150 Ω	
Positioning time	Positioning time	< 1 s	
Electrical connections	Cable entry	2 x Pg11 (ZM101/A, ZM121/A)	
	Connection terminals	max. 1 x 4 mm ² wire cross-section	
	Min. wire cross-section	0.75 mm ²	
Functional valve data	PN class	PN 32 to EN 1333	
	Permissible operating pressure	3.2 MPa (40 bar)	
	Max. differential pressure Δp_{max}	1 → 3	refer to «Type summary» table
		2 → 3	0.8 MPa (8 bar)
	Leakage at $\Delta p = 100$ kPa (1 bar)	1 → 3	max. 0.05 % k_{vs}
		2 → 3	max. 0.5 % k_{vs}
	Valve characteristic (stroke, k_v)	linear (to VDI / VDE 2173), optimized in low opening range	
	Permissible media	for safety refrigerants (R22, R134a, R404A, R407C, R507 etc.). Not suited for ammonia (R717)	
	Medium temperature	-40...120 °C	
	Position when de-energized	1 → 3 closed	
	Orientation	upright to horizontal	
	Type of operation	modulating	
	Materials	Valve body	steel
		Pipe connections	CU-pipe
		Seat / inner valve	brass / CrNi steel
Dimensions and weight	Dimensions	refer to «Dimensions»	
	Weight	refer to table in «Dimensions»	
Pipe connections	Sleeves	Extended female solder unions	
Norms and directives	Electromagnetic compatibility (Application)	For residential, commercial and industrial environments	
	Product standard	EN60730-x	
	EU Conformity (CE)	CA2T4722xx ²⁾	
	EAC Conformity	Eurasia conformity for all M3FK..	
	Housing protection	Upright to horizontal	IP54 to EN 60529
		Environmental compatibility	The product environmental declaration contains data on environmentally compatible product design and assessments (RoHS compliance, materials composition, packaging, environmental benefit, disposal).

Pressure Equipment directive	PED 2014/68/EU
Pressure accessories	Scope: Article 1, section 1 Definitions: Article 2, section 5
Fluid group 2	• DN15...DN32
Fluid group 1	• DN15...DN25
Fluid group 2	• DN40...DN50
	• without CE-marking as per article 4, section 3 (sound engineering practice) • category I, module A, with CE-marking

¹⁾ No operating voltage is required for the DC 0...20 V Phs power positioning signal.

²⁾ The documents can be downloaded from <http://siemens.com/bt/download>

General environmental conditions

	Operation EN 60721-3-3	Transport EN 60721-3-2	Storage EN 60721-3-1
Climatic conditions	Class 3K6	Class 2K3	Class 1K3
Temperature	-25...55 °C	-25...70 °C	-5...45 °C
Humidity	10...100 % r.h.	< 95 % r.h.	5...95 % r.h.

Connection terminals

Warning

If a ZM../A terminal housing is used with DC 0...20 V Phs (phase cut), AC 24 V must not be connected!

Always switch off the power supply before connecting or disconnecting the ZM.. terminal housing.

ZM101/A (DC 0...10 V or DC 0...20 V Phs)

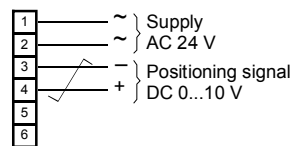

ZM111 (DC 0...20 V Phs)

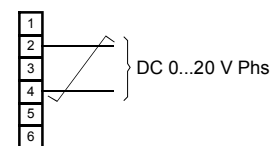

ZM121/A (DC 4...20 mA oder DC 0...20 V Phs)

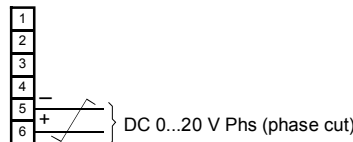
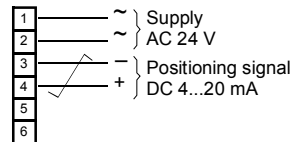

twisted pairs

4721Z00en

Connection diagrams

Refer to data sheet N4591 for the ZM.. terminal housings

Dimensions

Dimensions in mm

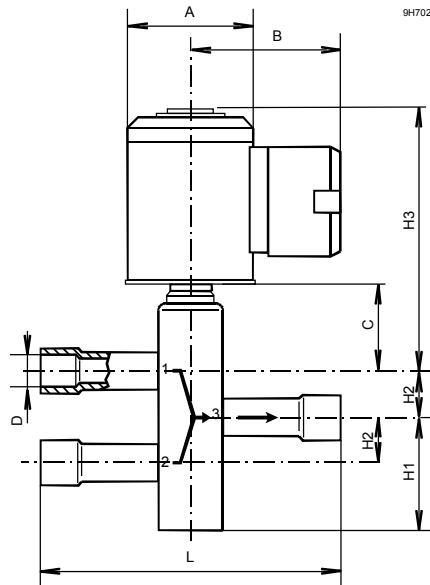

Valve type	DN [mm]	ø D [inches]	L	H ₁	H ₂	H ₃	A	B	C	W [kg]
M3FK15LX06	15	5/8	150	57	25	164	60	73	67	2.6
M3FK15LX15	15	5/8	150	57	25	164	60	73	67	2.6
M3FK15LX	15	5/8	150	57	25	164	60	73	67	2.6
M3FK20LX	20	7/8	170	62	30	173	70	78	67	3.5
M3FK25LX	25	1 1/8	200	66	36	177	70	78	71	4.2
M3FK32LX	32	1 3/8	250	91	43	197	80	84	80	6.0
M3FK40LX	40	1 5/8	300	92	50	202	100	94	98	10.7
M3FK50LX	50	2 1/8	350	102	60	202	100	94	85	12.0

D : Pipe connections
W : Weight (incl. packaging)

Revision numbers

Type reference	Valid up to rev. No.
M3FK15LX06	..F
M3FK15LX15	..F
M3FK15LX	..F
M3FK20LX	..F
M3FK25LX	..F
M3FK32LX	..G
M3FK40LX	..H
M3FK50LX	..H

Issued by
Siemens Switzerland Ltd
Building Technologies Division
International Headquarters
Gubelstrasse 22
6301 Zug
Switzerland
Tel. +41 41-724 24 24
www.siemens.com/buildingtechnologies

© Siemens Switzerland Ltd, 2010
Technical specifications and availability subject to change without notice.