



ACVATIX™

## Modulating control valve    MXG462S.. with magnetic actuator, PN16

stainless steel

- 
- Short positioning time (< 2 s), high-resolution stroke (1 : 1000)
  - Selectable valve characteristic: equal-percentage or linear
  - High rangeability
  - Operating voltage AC / DC 24 V
  - Selectable standard signal inputs DC 0/2...10 V or DC 0/4...20 mA
  - DC 0...20 V Phs phase-cut signal input for Staefa controllers
  - Indication of operating state, visible from the outside
  - Wear-free inductive stroke measurement
  - Low friction, robust and maintenance-free
  - Spring return facility: A → AB closed when de-energized
  - Positioning control, position feedback and manual control
  - Parts in contact with medium in CrNi steel

### Use

---

The control valves MXG462S.. are mixing or through-port valves. They are supplied with the magnetic actuator ready fitted, equipped with an electronics module for position control and position feedback.

The short positioning time, high resolution and high rangeability make these valves ideal for modulating control of open and closed circuits with the highest control requirements.

## Type summary

Type reference	DN	Connection [inch]	$k_{vs}$ [m <sup>3</sup> /h]	$\Delta p_{max}$ [kPa]	$\Delta p_s$ [kPa]	Operating voltage	Positioning		Spring return function
							signal	time	
MXG462S50-30	50	G 2 <sup>3</sup> / <sub>4</sub> B	30	600	600	AC 24 V DC 20...30 V	DC 0/2...10 V or DC 0/4...20 mA	< 2 s	✓

DN = Nominal size

$k_{vs}$  = Nominal flow rate of cold water (5 to 30 °C) through the fully opened valve ( $H_{100}$ ) at a differential pressure of 100 kPa (1 bar)

$\Delta p_{max}$  = Maximum permissible differential pressure across the valve's control path, valid for the entire actuating range of the motorized valve (mixing: path A-AB, B-AB)

$\Delta p_s$  = Maximum permissible differential pressure at which the motorized valve will close securely against the pressure (close off pressure)

### Accessories

Type reference	Description
Z366	Stem heating element for media temperatures < 0 °C, AC / DC 24 V, 10 W

### Ordering

Valve body and magnetic actuator form one assembly and cannot be separated.

When placing an order, please specify the quantity, product description and type code.

Example:	Type reference	Stock number	Description	Quantity
	MXG462S50-30	MXG462S50-30	Modulating control valve with magnetic actuator	2
	Z366	Z366	Stem heating element	2

**Delivery** A CrNi-steel seal disc is part of the delivery.  
Union fittings and gaskets must be supplied by the installer.  
The Z366 stem heating is delivered in a separate package.

### Rev. no.

Overview table, see page 11.

### Replacement electronics module ASE12

Should the valve electronics prove faulty, the electronics module must be replaced by the ASE12 replacement electronics module. Mounting instruction no. 74 319 0404 0 is included.

## Technical and mechanical design

For a detailed description of operation, refer to data sheet CA1N4028E.

### Control operation

The electronics module converts the positioning signal to a phase-cut power signal which generates a magnetic field in the coil. This causes the armature to change its position in accordance with the interacting forces (magnetic field, counter spring, hydraulics). The armature responds rapidly to any change in signal, transferring the corresponding movement directly to the valve plug, enabling fast changes in load to be corrected quickly and accurately.

The valve's position is measured continuously (inductive). The internal positioning controller balances any disturbance in the system rapidly and delivers the position feedback signal. The valve stroke is proportional to the positioning signal.

### Control

The magnetic actuator can be driven by a Siemens controller or a controller of other manufacture that deliver a Dc 0...10 V, DC 2...10 V, DC 0...20 mA or DC 4...20 mA output signal.

To achieve optimum control performance, it is recommended to use a 4-wire connection. In case of DC power supply, a 4-wire connection is **mandatory!**

### Spring return facility

If the positioning signal is interrupted, or in the event of a power failure, the valve's return spring will automatically close control path A → AB

## Manual control

### MANUAL

By pressing (a) and turning (b) the hand wheel in:

- clockwise (CW) direction, control path A → AB can be mechanically opened to between 80...90 %.

### OFF

By pressing (a) and turning (b) the hand wheel in:

- counterclockwise (CCW) direction, the actuator will be switched off and the valve closed.

As soon as the hand wheel is pressed and turned, neither the forced control signal Z nor the input signal Y or the phase-cut signal acts on the actuator. The green LED will flash.

### AUTO

For automatic control, the hand wheel must be set to the Auto position. The green LED will be lit.

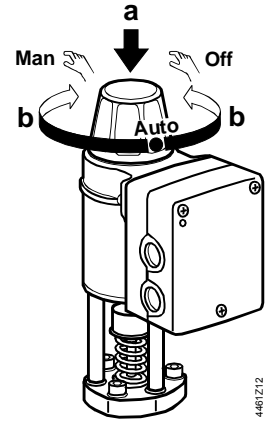

4461Z12

## Operator controls and indicators in the electronics housing

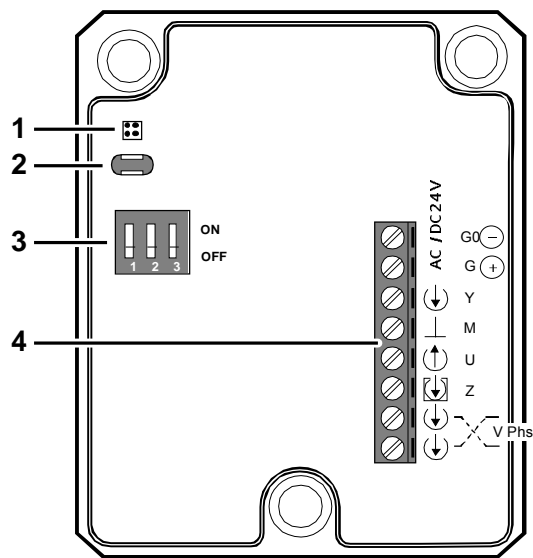

1 LED for indication of operating stat

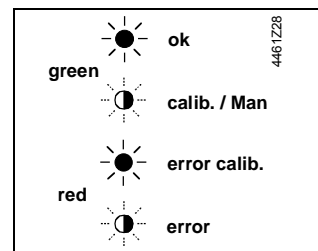

2 Opening for auto calibration

3 DIL switch for mode control

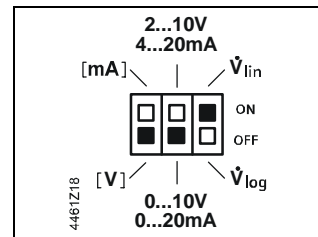

4 Connection terminals

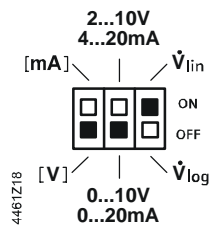

## Configuration DIL switches



Switch	Function	ON / OFF	Description
1 4461Z19	Positioning signal Y	ON	[mA]
		OFF	[V] <sup>1)</sup>
2 4461Z20	Positioning range Y and U	ON	2...10 V, 4...20 mA
		OFF	0...10 V, 0...20 mA <sup>1)</sup>
3 4461Z21	Valve characteristic	ON	$\dot{V}_{lin}$ (linear) <sup>1)</sup>
		OFF	$\dot{V}_{log}$ (equal-percentage)

<sup>1)</sup> Factory settings

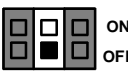
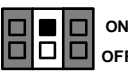
**Selection positioning signal and range Y**  
Voltage and current

 Y	 ON OFF	 ON OFF
 ON OFF	0...10 V	2...10 V
 ON OFF	0...20 mA	4...20 mA

4461Z22

**Selection positioning range Y and U:**  
0...10 V / 0...20 mA or  
2...10 V / 4...20 mA

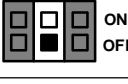
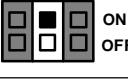
 U	 ON OFF	 ON OFF
Ri > 500 Ω	0...10 V	2...10 V
Ri < 500 Ω	0...20 mA	4...20 mA

4461Z23

Output signal U (position feedback signal) is dependent on the load resistance Ri.

Ri > 500 Ω, → voltage signal

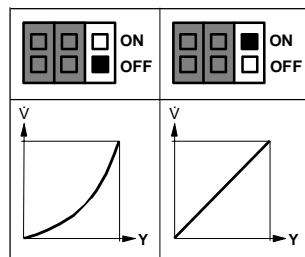

Ri < 500 Ω, → current signal

**Selection valve characteristics**  
Equal-percentage or linear



4461Z24

**Forced control input Z**

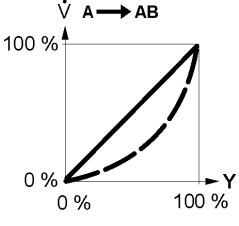
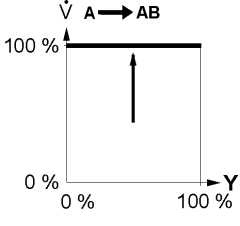
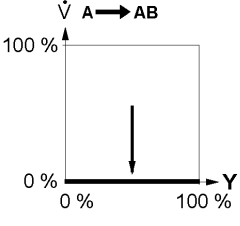
		Z - function		
		no function	fully open	closed
Connections				
	Transfer			
Function		<ul style="list-style-type: none"> <li>Z is not connected</li> <li>The valve will follow the Y-signal or phase-cut signal</li> </ul>	<ul style="list-style-type: none"> <li>Z connected to G</li> <li>The valve will fully open via control path A → AB</li> </ul>	<ul style="list-style-type: none"> <li>Z connected to G0</li> <li>The valve will close via control path A → AB</li> </ul>

4461Z13

**Signal priority**

1. Hand wheel position Man (open) or Off
2. Forced control signal Z
3. Phase-cut signal
4. Signal input Y

## Calibration



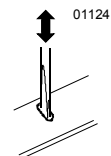

If the electronics module is replaced or the actuator turned through 180 °, the valve's electronics must be recalibrated. For that, the hand wheel must be set to Auto.

The printed circuit board has a slot (position 3, preceding page). Calibration is made by bridging the contacts located behind the slot using a screwdriver. The valve will then travel across the full stroke to store the end positions.



While calibration is in progress, the green LED will flash for about 10 seconds (also refer to «Indication of operating state»).

## Indication of operating state

LED	Indication	Function	Remarks, troubleshooting
Green	Lit 	Control mode	Normal operation; everything o.k.
	Flashing 	Calibration In manual control	Wait until calibration is finished (green or red LED will be lit) Hand wheel in Man or Off position
Red	Lit 	Calibration error Internal error	Recalibrate (bridge contacts behind the calibration slot) Replace electronics module
	Flashing 	Mains fault DC Supply - / +	Check mains network (outside the frequency or voltage range) DC supply + / - connection rectify
Both	Dark 	No power supply Electronics faulty	Check mains network, check wiring Replace electronics module

## Sizing

### Flow chart

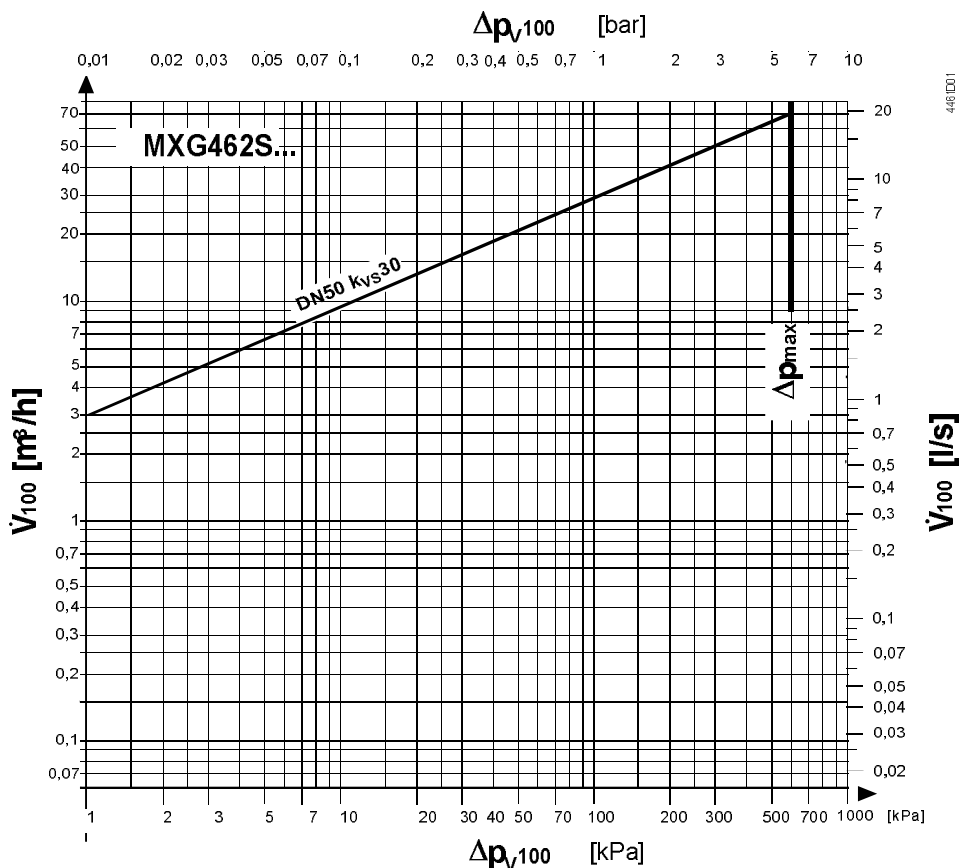

$\Delta p_{v100}$  = differential pressure across the fully open valve and the valve's control path by a volumetric flow  $V_{100}$

$\dot{V}_{100}$  = volumetric flow with valve fully open ( $H_{100}$ )

$\Delta p_{max}$  = maximum permissible differential pressure across the valve's control path, valid for the entire actuating range of the motorized valve (mixing: path A-AB, B-AB)

100 kPa = 1 bar  $\approx$  10 mWC

1 m<sup>3</sup>/h = 0.278 l/s water at 20 °C

## Valve characteristic

### Equal percentage

Volumetric flow

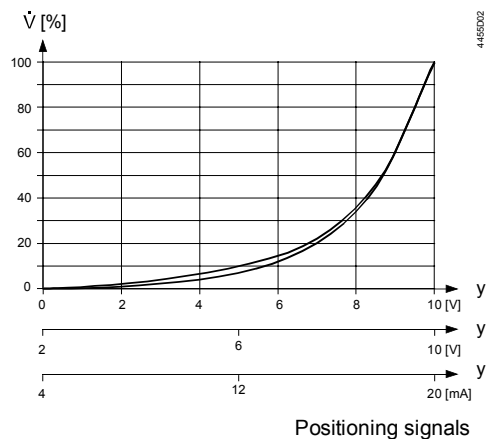

### Linear

Volumetric flow

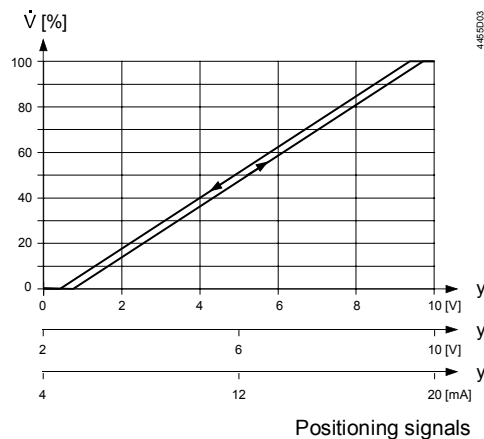

## Connection type <sup>1)</sup>

The 4-wire connection should always be given preference!

4-wire connection

Type reference	$S_{NA}$ [VA]	$P_{MED}$ [W]	$S_{TR}$ [VA]	$I_F$ [A]	wire cross-section [mm <sup>2</sup> ]		
					1,5	2,5	4,0
<b>MXG462S..</b>	65	22	100	6.3	30	50	80

$S_{NA}$  = nominal apparent power for selecting the transformer

$P_{med}$  = typical power consumption

$S_{TR}$  = Minimal require transformer power

$I_N$  = required slow fuse

L = max. cable length; with 4-wire connections, the max. permissible length of the separate 1.5 mm<sup>2</sup> copper positioning signal wire is 200 m

<sup>1)</sup> All information at AC 24 V

## Engineering notes

### Attention

Conduct the electric connections in accordance with local regulations on electric installations as well as the internal or connection diagrams.

**Safety regulations and restrictions designed to ensure the safety of people and property must be observed at all times!**



In open circuits, there is a risk of valve disc seizing caused by scale deposits. Additionally, periodic actuation (twice or three times per week) must be planned.



With closed and open circuits always use a strainer upstream of the valve to increase the valve's functional safety.

## Mounting notes

### Caution

The valve is supplied complete with Mounting Instruction no. 74 319 0378 0.

**The valve may only be used as a mixing or through port valve, not as a diverting valve. Observe the direction of flow A → AB!**

## Orientation

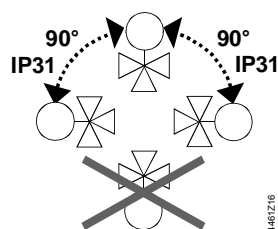

Degree of protection valid only when M20 cable gland supplied by the installer.

## When used as a through port valve

Threaded valves  
MXG462S.. as through-  
port valves

Only three-way MXG462S.. valves are supplied. They may be used as straight-through valves by closing off port «B».

Close off port B with a union fitting.

A Cr-Ni-Stahl seal disc with 3 gaskets is part of the delivery.

Union fittings conforming to ISO 49 / DIN 2950 must be supplied by the installer.

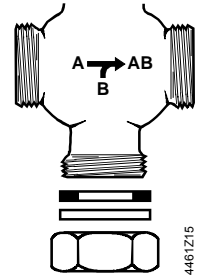

## Installation notes

- The MXG462S.. valves are flat-faced allowing sealing with the gaskets provided.
- Do not use hemp for sealing the valve body threads.
- The actuator may not be lagged.

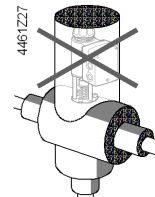
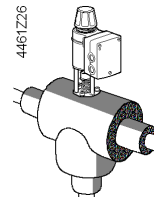
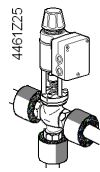

- For electrical installation, refer to «Connection diagrams», page 9.

## Maintenance notes

The valves are maintenance-free.

The low friction and robust design make regular servicing unnecessary and ensure a long service life. The valve stem is sealed from external influences by a maintenance-free gland.

If the red LED is lit, the electronics must be recalibrated or replaced.

## Repair

Should the valve electronics prove faulty, the electronics module must be replaced by the ASE12 replacement electronics module (refer to Mounting Instruction no 74 319 0404 0).

### Caution

**Always disconnect power before fitting or removing the electronics module.**

After replacing the electronics module, calibration must be triggered in order to optimally match the electronics to the valve (refer to «Calibration », page 5)

## Disposal



The valve is considered an electronics device for disposal in terms of European Directive 2012/19/EU and may not be disposed of as domestic garbage.

- Disassemble the valve into individual parts prior to disposing of it and sort the individual parts by the various types of materials.
- Comply with all local and currently applicable laws and regulations.

## Warranty

Application-specific technical data must be observed.

**If specified limits are not observed, Siemens Switzerland Ltd / HVAC Products will not assume any responsibility.**

## Technical data

### Functional actuator data

Power supply	Extra low-voltage only (SELV, PELV)		
AC 24 V	Operating voltage	AC 24 V +20 / -15 %	
	Frequency	45...65 Hz	
	Typical power consumption	$P_{MED}$	22 W
		Stand by	< 1 W (valve closed)
	Apparent power $S_A$	65 VA	
	Minimum power of transformer $S_{TR}$	100 VA	
DC 24 V	Required fuse $I_F$	6.3 A, slow	
	Operating voltage	DC 20...30 V	
Input	Current draw at DC 24 V	0.5 A / 4 A (max.)	
	Positioning signal Y or Phase Cut signal Phs	DC 0/2...10 V or DC 0/4...20 mA	
		0...20 V	
	Impedance	DC 0/2...10 V	100 k $\Omega$ // 5nF
		DC 0/4...20 mA	240 $\Omega$ // 5nF
	Forced control Z	Impedance	22 k $\Omega$
Close valve (Z connected to G0)		< AC 1 V; < DC 0.8 V	
Open valve (Z connected to G)		> AC 6 V; > DC 5 V	
No function (Z not wired)		phase-cut- or positioning signal Y active	
Output	Position feedback signal U	Voltage	DC 0/2...10 V; load resistance > 500 $\Omega$
		Current	DC 0/4...20 mA; load resistance $\leq$ 500 $\Omega$
	Stroke measurement Nonlinearity	Inductive $\pm$ 3 % of end value	
Positioning time	Positioning time	< 2 s	
Electrical connections	Cable entry point	2 x $\varnothing$ 20.5 mm (for M20)	
	Connecting terminal	terminal for 4 mm <sup>2</sup> wire	
	Min. wire cross-section	0.75 mm <sup>2</sup>	
	Max. cable length	refer to «connection type», page 5	
Functional valve data	PN class	PN 16 as per EN 1333	
	Permissible operating pressure <sup>1)</sup>	1.6 MPa (16 bar)	
	Differential pressure $\Delta p_{max} / \Delta p_s$	refer to table «Type summary», page 2	
	Valve characteristic <sup>2)</sup>	equal percentage or linear, $n_{gl} = 3$ as per VDI / VDE 2173, optimized near the closing point (refer to Data Sheet N4023)	
	Leakage rate at $\Delta p = 0.1$ MPa (1 bar)	A $\rightarrow$ AB	< 0.05 % of $k_{VS}$ value
		B $\rightarrow$ AB	< 0.2 % $k_{VS}$ depending on operation conditions
	Permissible media	chilled, cold and hot water, water with anti-freeze; recommendation: water treatment as per VDI 2035	
	Medium temperature <sup>3)</sup>	-20...130 $^{\circ}$ C	
	Stroke resolution $\Delta H / H_{100}$	1 : 1000 (H = stroke)	
	Mode of operation	modulating	
	Hysteresis	typical 3 %	
	Position when de-energized	A $\rightarrow$ AB closed	
	Mounting position	upright to horizontal (observe safety standard)	
Mode of operation	modulating		

Materials	Valve body, Covering flange	CrNi steel (1.4581)	
	Seat, inner valve, plug	CrNi steel	
	Entire inner suit	CrNi steel	
Dimensions / weight	Valve stem seal	EPDM (O-ring)	
	Dimensions / weight	refer to «Dimensions», page 11	
Norms and directives	Threaded connection	as per ISO 228-1	
	Electromagnetic compatibility (Application)	For residential, commercial and light-industrial environments	
	Product standard	EN60730-x	
	EU Conformity (CE)	CA2T4461.1 <sup>4)</sup>	
	RCM Conformity	A5W00004453 <sup>4)</sup>	
	EAC Conformity	Eurasia Conformity for all MXG..	
	Protection class	Class III as per EN 60730	
	Emissions	Class 2 as per EN 60730	
	Housing protection upright to horizontal	IP31 as per EN 60529	
	Vibration <sup>5)</sup>	IEC 68-2-6 (1 g acceleration, 1...100 Hz, 10 min)	
	Conforming to	UL CSA	UL 873 C22.2 No. 24
	Environmental compatibility	The product environmental declaration contains data on environmentally compatible product design and assessments (RoHS compliance, materials composition, packaging, environmental benefit, disposal).	
	Pressure Equipment Directive	PED 2014/68/EU	
Pressure accessories	Scope: Article 1, section 1 Definitions: Article 2, section 5		
Fluid group 2	without CE-marking as per article 4, section 3 (sound engineering practice)		

- <sup>1)</sup> Tested at 1.5 x PN (24 bar), similar to DIN 3230-3.
- <sup>2)</sup> Can be selected via DIL switch.
- <sup>3)</sup> Medium temperatures < 0 °C, the Z366 stem heating element is required.
- <sup>4)</sup> The documents can be downloaded from <http://siemens.com/bt/download>.
- <sup>5)</sup> In case of strong vibrations, use high-flex stranded wires for safety reasons.

### General environmental conditions

	Operation EN 60721-3-3	Transport EN 60721-3-2	Storage EN 60721-3-1
Climatic conditions	Class 3K5	Class 2K3	Class 1K3
Temperature	-5...+45 °C	-25...+70 °C	-5...+45 °C
Humidity	5...95 % r.h.	5...95 % r.h.	5...95 % r.h.
Mechanical conditions	EN 60721-3-6 Class 6M2		

### Connection terminals

4461A06	G0	⊖	AC / DC	System neutral AC 24 V, DC 20...30 V
	G	⊕		System potential AC 24 V, DC 20...30 V
	Y	⬇		Control signal DC 0/2...10 V, DC 0/4...20 mA
	M	⊥		Measuring neutral (= G0)
	U	⬆		Position feedback signal DC 0/2...10 V, DC 0/4...20 mA
	Z	⬇		Forced- control input Z
	Ph	⬇	Phs	Phase-cut signal DC 0...20 V Phs, interchangeable, galvanically isolated
	Ph	⬇	Phs	Phase-cut signal DC 0...20 V Phs, interchangeable, galvanically isolated

Connection diagrams

**Caution** ⚠ If controller and valve receive their power from separate sources, only one transformer may be earthed on the secondary side.

**Caution** ⚠ In case of DC power supply, a 4-wire connection is mandatory!

**Terminal assignment for controller with 4-wire connection (to be preferred!).**

- DC 0...10 V
- DC 2...10 V
- DC 0...20 mA
- DC 4...20 mA

Common Transformer

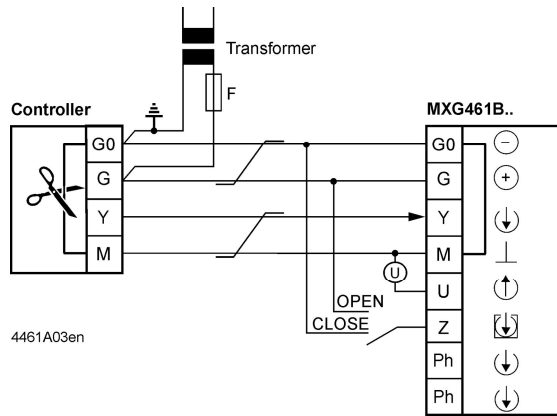

Separate Transformer

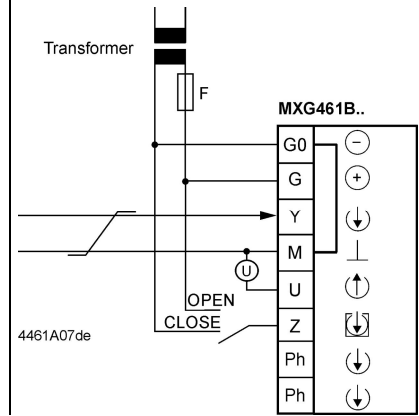

**Terminal assignment for controller with 3-wire connection**

- DC 0...10 V
- DC 2...10 V
- DC 0...20 mA
- DC 4...20 mA

Common Transformer

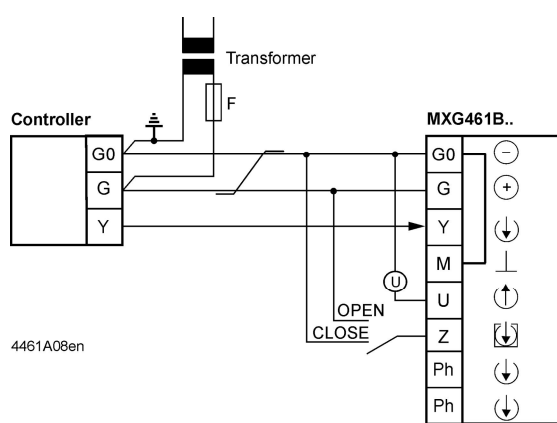

Separate Transformer

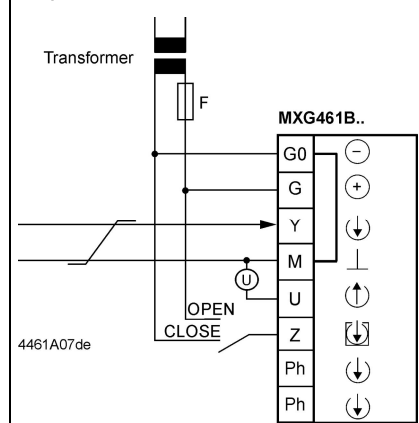

Ⓢ Indication of valve position (only if required). DC 0 ...10 V → 0...100 % volumetric flow  $V_{100}$   
 Twisted pairs. If the lines for AC 24 V power supply and the DC 0...10 V (DC 2...10 V, DC 4... 20 mA) positioning signal are routed separately, the AC 24 V line need not be twisted.

**Warning**

**Piping must be connected to potential earth!**

**Controllers with phase-cut**  
DC 0...20 V Phs

Common Transformer

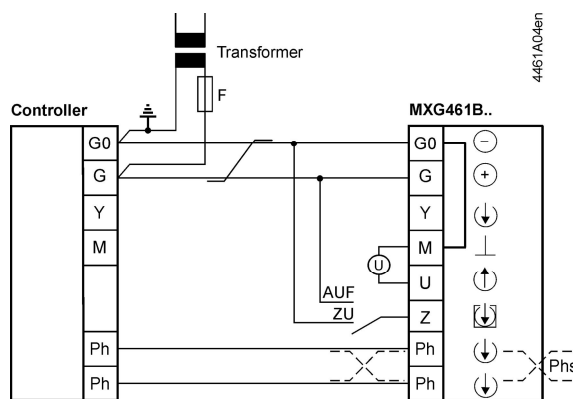

Separate Transformer

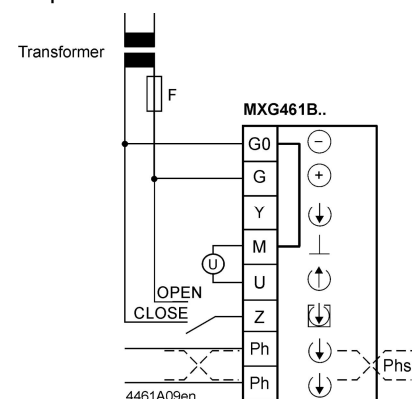

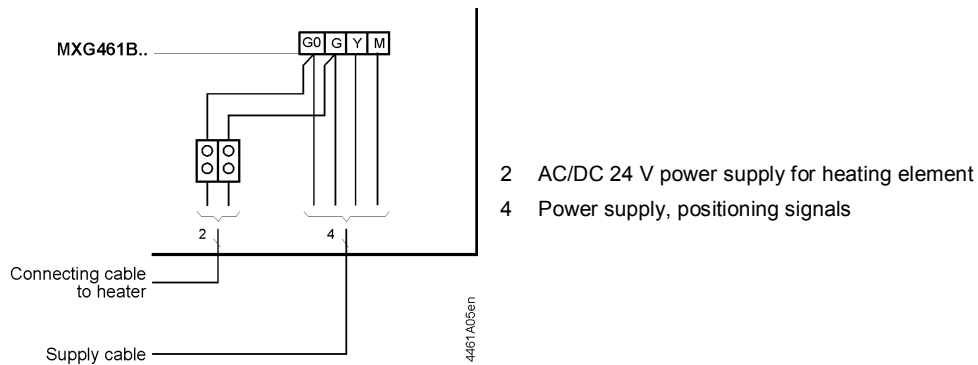

**Stem heating element**  
Z366

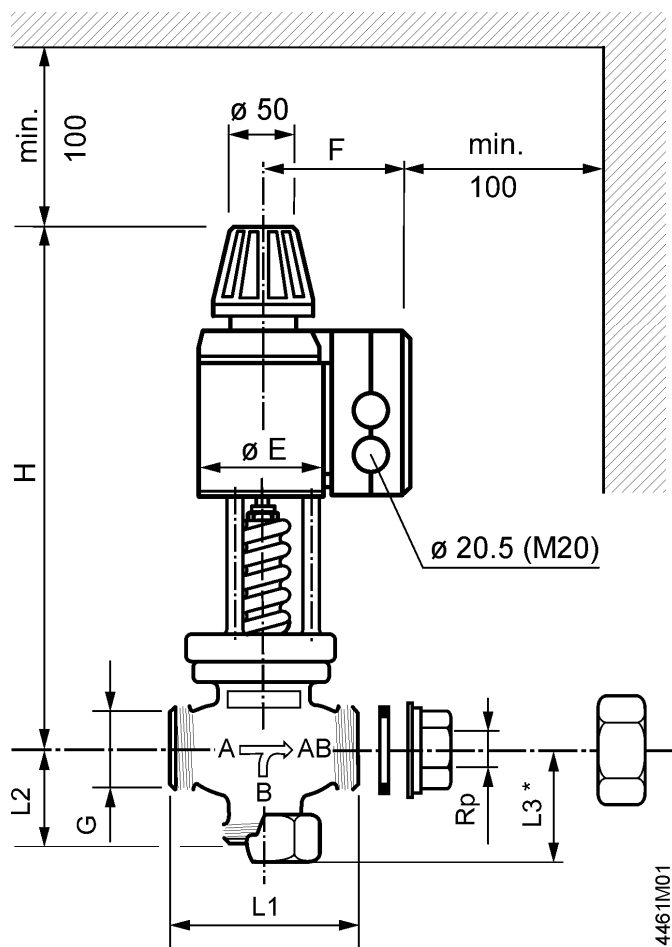

## Dimensions

Dimensions in mm



Type reference	DN	G	Rp	L1	L2	L3*	H	E	F	 <sup>1)</sup>
		[Inch]	[Inch]	[mm]	[mm]	[mm]	[mm]	[mm]	[mm]	[kg]
<b>MXG462S50-30</b>	50	G 2½B	Rp 2	170	93,5	108	402	100	125	18,6

- Externally thread G...B as per ISO 228-1
- Internally thread Rp... as per ISO 7-1
- Union fittings as per ISO 49 / DIN 2950

\* When used as through port valve  
G Weight in kg (incl. packaging)

## Revision numbers

Type reference	Valid from rev. No.
MXG462S50-30	..A

Issued by  
Siemens Switzerland Ltd  
Building Technologies Division  
International Headquarters  
Gubelstrasse 22  
6301 Zug  
Switzerland  
Tel. +41 41-724 24 24  
[www.siemens.com/buildingtechnologies](http://www.siemens.com/buildingtechnologies)

© Siemens Switzerland Ltd, 2005  
Technical specifications and availability subject to change without notice.